

HOELSCHER

WEATHERSTRIP MANUFACTURING

Contemporary Doors



TRADITIONAL MAHOGANY DOORS • TRADITIONAL KNOTTY ALDER DOORS
CONTEMPORARY DOORS • BARN DOORS • TRUE DIVIDED LITE DOORS
BEVELED, TEXTURED & INSULATED GLASS • CLAVOS • STRAPS
IRON GRILLES • SIDELITES • TRANSOMS • SPEAKEASIES
JAMBS • MOULDING • WEATHERSTRIP • HARDWARE



CONTEMPORARY COLLECTION

3/0 x 6/8		3/0 x 8/0	
5 LITE HORIZONTAL	3	3 LITE	4
4 LITE	3	5 LITE	4
3 LITE	3	6 LITE HORIZONTAL	4
		1 LITE VERTICAL	5
		7 PANEL	5
3/6 x 8/0			
3 LITE	4		
5 LITE	4		
1 LITE VERTICAL	5		
7 PANEL	5		

The Contemporary Collection doors feature clean modern construction details. Square edged flush glass bead creates a contemporary, modern appearance. Engineered wood stiles and rails with multiple hardwood dowels at their connection points assure the homeowner of a beautiful, safe, solid and stable hardwood door. Six textured glass options are offered interchangeably across the entire Contemporary Collection.

2

Contemporary Insulated Glass Options

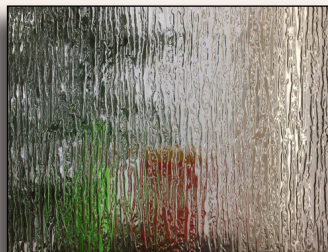

#1 Rain (6)

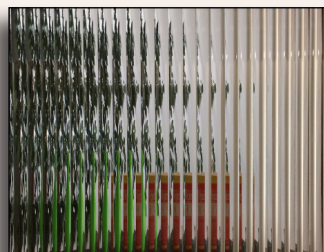

#2 Reeded (7)

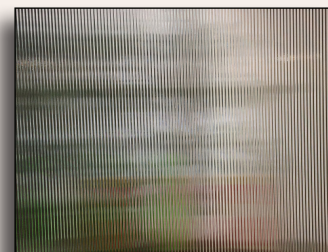

#3 Small Reeded (8)

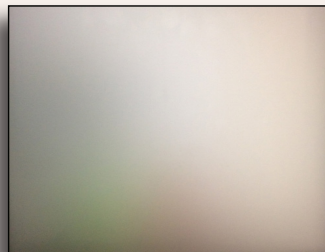

#4 Satin (9)

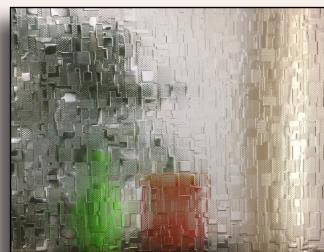

#5 Digital (4)



#6 Sandblast & Clear Border (3)

Privacy ratings (shown in Parenthesse) are subjective and open to interpretation. The higher the privacy rating, the more private and less transparent that particular textured glass option will be.

6/8 Contemporary Collection

5 Lite Horizontal

Mahogany Door

Size	Stock Number	Glass
36"	M5HGRN3068	1
36"	M5HGR3068	2
36"	M5HGR3068	3
36"	M5HGSN3068	4
36"	M5HGD3068	5
36"	M5HG5B3068	6

Insulated Glass Options

- 1 Rain
- 2 Reeded
- 3 Small Reeded
- 4 Satin
- 5 Digital
- 6 Sandblast with Clear Border

Shown with Rain Glass
Privacy rating: 6 as shown.



4 Lite

Mahogany Door

Size	Stock Number	Glass
36"	M4GPWRN3068	1
36"	M4GPWR3068	2
36"	M4GPWSR3068	3
36"	M4GPWSN3068	4
36"	M4GPWD3068	5
36"	M4GPWSB3068	6

Insulated Glass Options

- 1 Rain
- 2 Reeded
- 3 Small Reeded
- 4 Satin
- 5 Digital
- 6 Sandblast with Clear Border

Shown with Small Reeded Glass
Privacy rating: 8 as shown.



Insulated Glass Cross Section

Isometric view with beveled glass

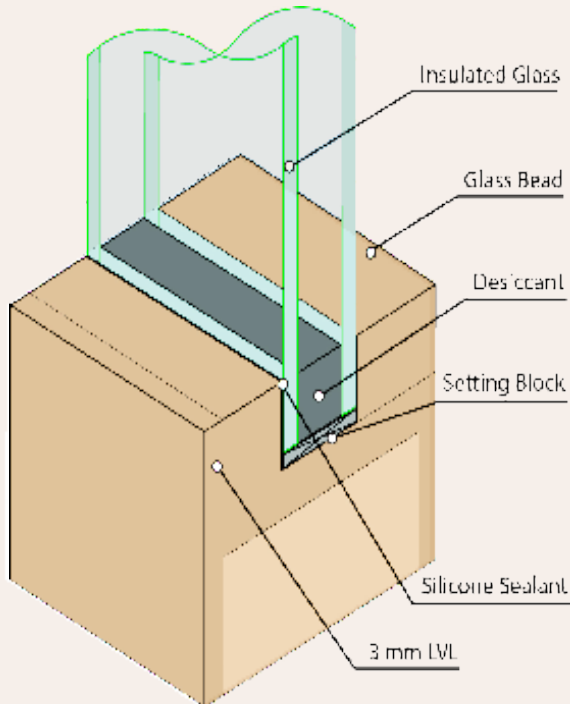

3 Lite

Mahogany Door

Size	Stock Number	Glass
36"	M3GPWRN3068	1
36"	M3GPWR3068	2
36"	M3GPWSR3068	3
36"	M3GPWSN3068	4
36"	M3GPWD3068	5
36"	M3GPWSB3068	6

Insulated Glass Options

- 1 Rain
- 2 Reeded
- 3 Small Reeded
- 4 Satin
- 5 Digital
- 6 Sandblast with Clear Border

Shown with Rain Glass
Privacy rating: 6 as shown.



8/0 Contemporary Collection

3 Lite

**Mahogany Door**

Size	Stock Number	Glass
36"	M3GPWRN3080	1
36"	M3GPWR3080	2
36"	M3GPWSR3080	3
36"	M3GPWSN3080	4
36"	M3GPWD3080	5
36"	M3GPWSB3080	6
42"	M3GPWRN3680	1
42"	M3GPWR3680	2
42"	M3GPWSR3680	3
42"	M3GPWSN3680	4
42"	M3GPWD3680	5
42"	M3GPWSB3680	6

Insulated Glass Options

- 1 Rain
- 2 Reeded
- 3 Small Reeded
- 4 Satin
- 5 Digital
- 6 Sandblast with Clear Border

Shown with Satin Glass

Privacy rating: 9 as shown.

5 Lite

**Mahogany Door**

Size	Stock Number	Glass
36"	M5GPWRN3080	1
36"	M5GPWR3080	2
36"	M5GPWSR3080	3
36"	M5GPWSN3080	4
36"	M5GPWD3080	5
36"	M5GPWSB3080	6
42"	M5GPWRN3680	1
42"	M5GPWR3680	2
42"	M5GPWSR3680	3
42"	M5GPWSN3680	4
42"	M5GPWD3680	5
42"	M5GPWSB3680	6

Insulated Glass Options

- 1 Rain
- 2 Reeded
- 3 Small Reeded
- 4 Satin
- 5 Digital
- 6 Sandblast with Clear Border

Shown with Sandblast with Clear Border Glass

Privacy rating: 3 as shown.

6 Lite Horizontal

**Mahogany Door**

Size	Stock Number	Glass
36"	M6HGRN3080	1
36"	M6HGR3080	2
36"	M6HGSR3080	3
36"	M6HGSN3080	4
36"	M6HGD3080	5
36"	M6HGSB3080	6

Insulated Glass Options

- 1 Rain
- 2 Reeded
- 3 Small Reeded
- 4 Satin
- 5 Digital
- 6 Sandblast with Clear Border

Shown with Rain Glass

Privacy rating: 6 as shown.



8/0 Contemporary Collection

1 Lite Vertical

Mahogany Door

Size	Stock Number	Glass
36"	M1LVRN3080	1
36"	M1LVR3080	2
36"	M1LVS3080	4
36"	M1LVD3080	5
36"	M1LVS3080	6
42"	M1LVRN3680	1
42"	M1LVR3680	2
42"	M1LVS3680	4
42"	M1LVD3680	5
42"	M1LVS3680	6
2-1/4" Thickness		
42"	M1LVRN3680-2	1
42"	M1LVR3680-2	2
42"	M1LVS3680-2	4
42"	M1LVD3680-2	5
42"	M1LVS3680-2	6

Small Reeded glass is unavailable in this configuration.

Shown with Reeded Glass
Privacy rating: 7 as shown.



7 Panel

Mahogany Door

Size	Stock Number
36"	M7P3080
42"	M7P3680
2-1/4" Thickness	
42"	M7P3680-2



Available door unit configurations: 1-3, 8. See page 5 for more information.

Contemporary Stain Selections

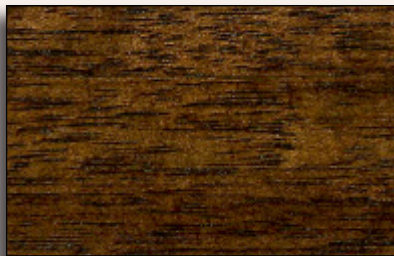

JACOBEAN



SPECIAL WALNUT

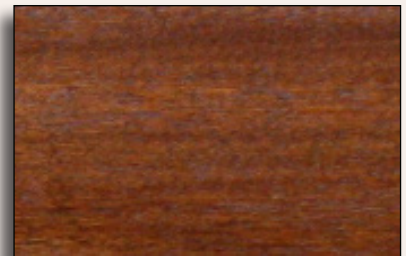

ENGLISH CHESTNUT

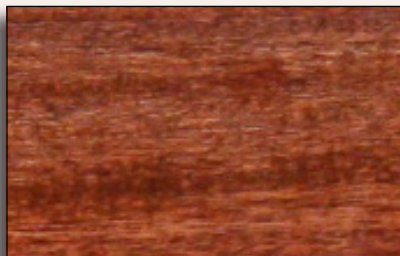

RED OAK

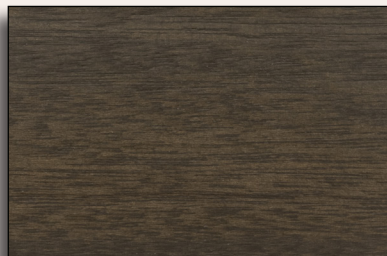

AGED BARREL

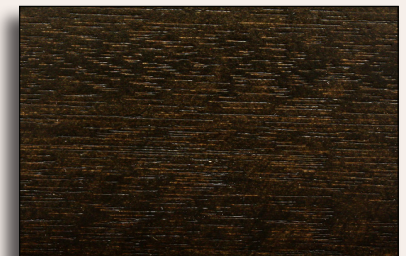

EBONY

JAMB COMPONENTS

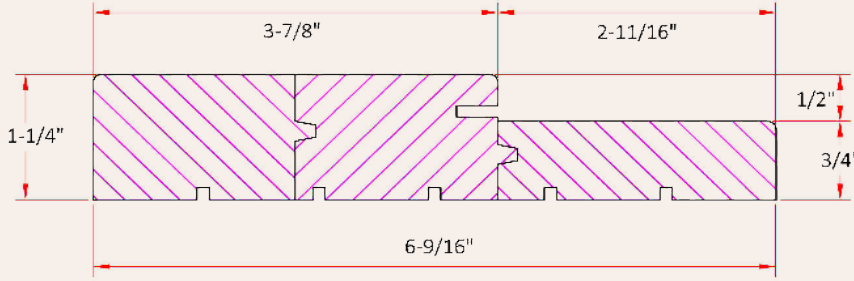

MJ680-2 6-9/16" Mahogany Jamb 8-0 100" (2-1/4" thick door)
KAJ680-2 6-9/16" Knotty Alder Jamb 8-0 100" (2-1/4" thick door)

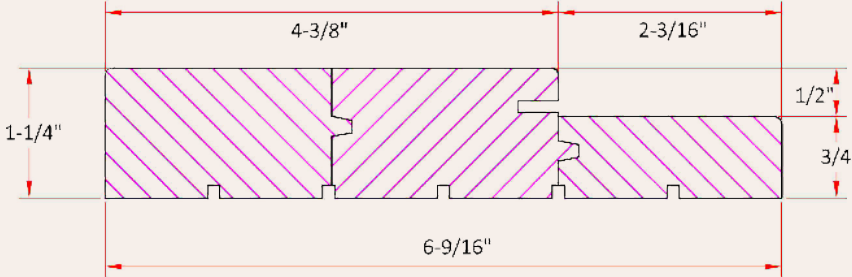

MJ680 6-9/16" Mahogany Jamb 8-0 100" (1-3/4" thick door)
KAJ680 6-9/16" Knotty Alder Jamb 8-0 100" (1-3/4" thick door)

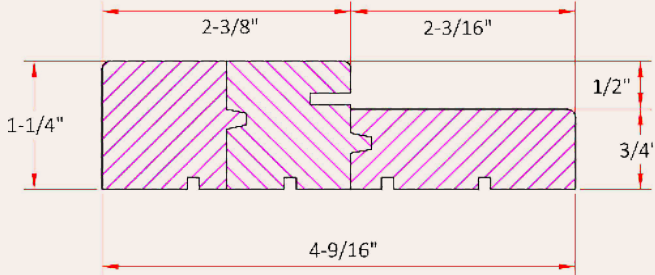

MJ480 4-9/16" Mahogany Jamb 8-0 100" (1-3/4" thick door)
KAJ480 4-9/16" Knotty Alder Jamb 8-0 100" (1-3/4" thick door)

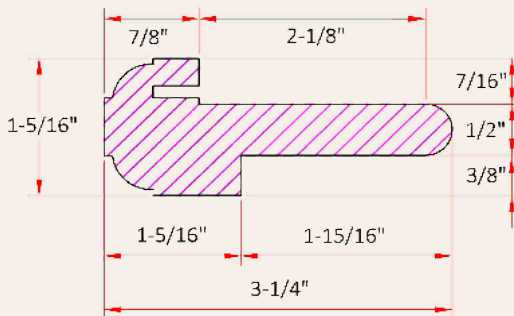

MTAST1280 1/2" Mahogany T-Astragal 8-0 96" (1-3/4" thick door)
KATAST1280 1/2" Knotty Alder T-Astragal 8-0 96" (1-3/4" thick door)

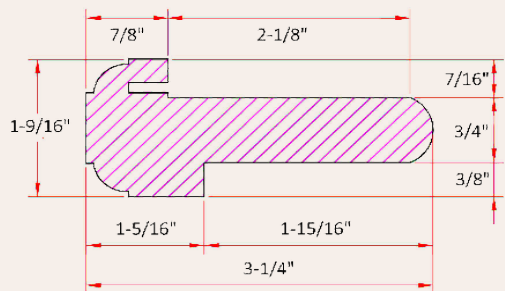

MTAST3480 3/4" Mahogany T-Astragal 8-0 96" (1-3/4" thick door)
KATAST3480 3/4" Knotty Alder T-Astragal 8-0 96" (1-3/4" thick door)

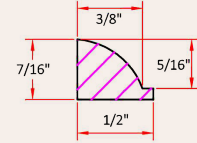

Scale: 1:2

MGB80 Mahogany Glass Bead 8-0 100"
KAGB80 Knotty Alder Glass Bead 8-0 100"

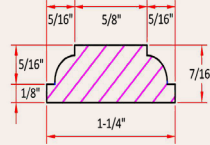

MIMC80 Mahogany Interior Mull Cover 8-0 100"
KAIMC80 K. Alder Interior Mull Cover 8-0 100"

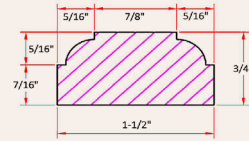

MXMC80 Mahogany Exterior Mull Cover 8-0 100"
KAXMC80 K. Alder Exterior Mull Cover 8-0 100"

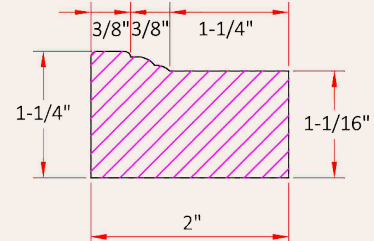

MBMC80 Mahogany Brick Mould 8-0 104"
KABMC80 Knotty Alder Brick Mould 8-0 104"

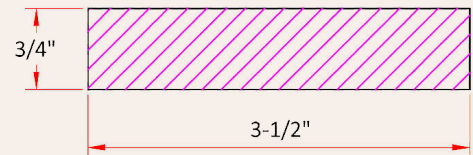

MSC80 Mahogany 1x4 Casing 8-0 104"
KASC80 Knotty Alder 1x4 Casing 8-0 104"

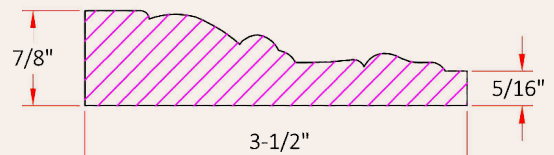

MCSG380 Mahogany Casing 8-0 104"
KACSG380 Knotty Alder Casing 8-0 104"

Rough Opening Schedule

SINGLE DOORS	config.*	width x height	DOUBLE DOORS	config.*	width x height
2/0 x 6/8	1	26-1/4" x 84"	(2) 2/0 x 6/8	8	51-1/2" x 84"
2/6 x 6/8	1	32-1/4" x 84"	(2) 2/6 x 6/8	8	63-1/2" x 84"
2/8 x 6/8	1	34-1/4" x 84"	(2) 2/8 x 6/8	8	67-1/2" x 84"
3-0 x 6/8	1	38-1/4" x 84"	(2) 3-0 x 6/8	8	75-1/2" x 84"
3/6 x 6/8	1	44-1/4" x 84"			
4/0 x 6/8	1	50-1/4" x 84"			

* Make openings for 8/0 doors 100" tall

* Make openings for 8/0 doors 100" tall

SIDELIGHT UNITS	configuration*	width x height
Single 3/0 x 6/8 with one 12" sidelight	2	52" x 84"
Single 3/0 x 6/8 with two 12" sidelights	3	65-1/2" x 84"
Single 3/0 x 6/8 with one 14" sidelight	2	54" x 84"
Single 3/0 x 6/8 with two 14" sidelights	3	69-1/2" x 84"

* Make openings for 8/0 doors 100" tall

TRANSOM UNITS	configuration*	height
6/8 units with 2 - 12" sidelites and a 12" rectangular transom	4	97-1/2"
6/8 units with 2 - 14" sidelites and a 14" rectangular transom	4	99-1/2"
8/0 units with 2 - 12" sidelites and a 12" rectangular transom	4	113-1/2"
8/0 units with 2 - 14" sidelites and a 14" rectangular transom	4	115-1/2"
6/8 units with 2 - 12" sidelites and a 19-3/8" segment transom	5	103-3/8"
6/8 units with 2 - 14" sidelites and a 20-1/2" segment transom	5	104-1/2"
8/0 units with 2 - 12" sidelites and a 19-3/8" segment transom	5	119-3/8"
8/0 units with 2 - 14" sidelites and a 20-1/2" segment transom	5	120-1/2"
6/8 units with 2 - 12" sidelites and a 17-1/4" elliptical transom	6	101-1/4"
6/8 units with 2 - 14" sidelites and a 19-1/4" elliptical transom	6	103-1/4"
8/0 units with 2 - 12" sidelites and a 17-1/4" elliptical transom	6	117-1/4"
8/0 units with 2 - 14" sidelites and a 19-1/4" elliptical transom	6	119-1/4"
6/8 units with 2 - 12" sidelites and a 31-1/2" half round transom	7	115-1/2"
6/8 units with 2 - 14" sidelites and a 33-1/2" half round transom	7	117-1/2"
8/0 units with 2 - 12" sidelites and a 31-1/2" half round transom	7	131-1/2"
8/0 units with 2 - 14" sidelites and a 33-1/2" half round transom	7	133-1/2"

***Door Unit Configurations - page 5.**

The rough opening dimensions were configured using Hoelscher prehung specifications.



HOELSCHER

WEATHERSTRIP MANUFACTURING CO., INC.

2400 S. Persimmon Street Tomball, TX 77375

* Phone 713-869-6466 * Fax 713-869-6469 * Door Fax 713-861-2909

PRODUCT CERTIFICATIONS

WINDSTORM CERTIFICATION

Our products are tested for windstorm certification according to the standards set by the Texas Department of Insurance and the Florida Building Code. For a listing of certified products, and to view certification documents, please refer to web pages <http://www.tdi.texas.gov/wind/prod/indexdr.html> or http://www.floridabuilding.org/pr/pr_app_srch.aspx

8

To find our products on the Texas Department of Insurance website look for products with Hoelscher Weatherstrip Manufacturing Co., Inc. in the Manufacturer Distributor field under Hinged Doors - Wood - Non-Impact Resistant. Multiple product configurations may be found within a single report.

To find our products on the Florida Building Code website simply search our FL#, FL16575, in the FL field at the [Floridabuilding.org](http://www.floridabuilding.org) site listed above.

Product certifications are updated periodically, including the addition of new products and new product configurations, and any of these changes/updates will be reflected on these websites.

GLASS CERTIFICATION

The glass supplied by Hoelscher Weatherstrip is certified to the ANZI Z 97.1 2015 and CPSC 1201 II standards. 1/8" tempered glass have an SGCC 5127 1/8 UA certification and 1/4" tempered glass hve an SGCC 3584 1/4 UA certification.

NAMI CERTIFICATION

Our products all comply with the standards of, and are registered with, NAMI.



HOELSCHER

WEATHERSTRIP MANUFACTURING CO., INC.

2400 S. Persimmon Street Tomball, TX 77375

* Phone 713-869-6466 * Fax 713-869-6469 * Door Fax 713-861-2909

Wood Entry Door Collection Warranty

Hoelscher Weatherstrip Mfg. Co., Inc. offers a limited warranty for one (1) year on all wood doors from the original date of installation of the door. This warranty assures that each such door, for this period, is of good material and workmanship, and free from defects rendering the door unserviceable or unfit for the ordinary, recommended use. This warranty shall be void if the door has not been stored, installed, and maintained in a good workable manner. If the door is installed unfinished, the warranty is void unless the door is sealed within a 72 (seventy two hour) period. During this period, if the door is exposed to rain or any water infiltration, the warranty shall be void.

Conditions not Considered Defects Covered by the Hoelscher Warranty

The following conditions are not considered defects which are covered under the Hoelscher warranty: warp (as defined and within the limits prescribed below) ; bow or misalignment of the frame or jamb in which the door is hung; variation or unsatisfactory results in the surface checking of the wood; damage resulting from the causes beyond the control of Hoelscher (within the limits prescribed below); defects from failure to perform normal home owner maintenance or from attempts by non-Hoelscher workmen to repair the door; surface checks on the door that are less than 1/32" in width or less than 2" in length; panel movement or shrinkage of 3/16" or less (temperature, humidity, and direct sunlight may cause the wood panels on your door to shrink slightly, leaving an unstained line in the panel. This movement is normal and the door's construction is designed to allow this movement.); damage caused by the installation of a storm door; leakage in the speakeasy opening in doors with such a feature (with or without decorative iron grille); reducing the height of the door by removing more than one (1") inch from the bottom rail and/or one-half (1/2") inch from the top rail of the door; reducing the width of the door by removing more than one-half (1/2") inch from the stiles at either side. Warp, as mentioned above, is defined as any distortion in the door itself, and does not refer to the frame or jamb in which it is hung. However, the term, "warp" shall not include the related terms of "bow", "cup", or "twist." To be considered warped for the purposes of the warranty; the distortion would have to exceed 1/4" on a 6'8" tall door and 1/2" on an 8'0" tall door. Doors wider than 36 inches or taller than 8 feet are not warranted against warp. If the claimed nonconformity is warp, Hoelscher may defer repairing or replacing the product for up to twelve (12) months from the date of the claim of the date when the products was installed, as it is not uncommon for temporary warp conditions to occur as the door adjusts to local humidity and temperature. The aforementioned damages caused by forces beyond Hoelscher's control include, but are not limited to, damage caused by misuse, abuse, accident, mishandling, fire, flood, earthquake, storm, tornado, or other acts of nature. In addition to the above, the Hoelscher warranty does not cover any damages including fading of finish, discoloration, rust or flaking resulting from exposure due to installation without sufficient roof overhang protection, which causes the door to be exposed to an unusual amount of sunlight and /or precipitation. Minimum roof overhang is one in which the roof overhang projects out a distance from the structure no less than one-half (1/2) of the elevation between the bottom of the door and the base of the overhangs highest point above the entryway.

Prefinished Doors

Hoelscher Weatherstrip Mfg. Co. offers a twelve (12) month warranty on all of our prefinished doors. The warranty period begins on the original date of purchase.

Glass Panels

Hoelscher Weatherstrip Mfg. Co. does not warrant any product against glass breakage or glass damage for any reason.

"IG" Insulated Glass Panels

Your insulated glass panel is warranted for a period of two (2) years from the original date of installation. It is warranted against any material obstruction of vision through the unit due to accumulation of dust, moisture, or film on the internal surfaces caused by the failure of the unit's edge seal due to defects in material or workmanship under normal conditions. This warranty shall be void if; the unit is installed in high moisture environments (such as greenhouses or swimming pool enclosures) or film, shades, blinds, or any foreign materials, are used on or near the surface of the unit.

Claim Procedures and Limit on Remedies

All warranty claims must be presented within the warranty period for the specific product as outlined above. Hoelscher will not honor warranty claims made prior to payment in full for the warranted product. Upon validation by Hoelscher of any warranty claim, Hoelscher will at its option: 1) Repair the product and return it FOB our Houston, Texas facility, freight collect: 2) furnish a comparable replacement product (or if the product is no longer produced, a replacement which, in the sole opinion of Hoelscher, constitutes a comparable replacement) FOB our Houston, Texas facility, freight collect: 3) Refund the purchase price paid by the original purchaser of the product by Hoelscher. Hoelscher Weatherstrip Mfg. Co., Inc. reserves the right to inspect, in the field or on our premises, any product which is alleged to be defective, and must be given a thirty (30) day opportunity to have any door which is subject of a warranty claim field inspected by a company or field representative of Hoelscher.



Knotty Alder



Mahogany



Divided Lite



Barn



Iron Grille



Contemporary

Hoelscher Weatherstrip Manufacturing Co., Inc.

2400 S. Persimmon Street Tomball, TX 77375

Phone: 713-869-6466

Fax: 713-869-6469

HoelscherWeatherstrip.com